

elleerre[®]

Dove c'è passione

OUR SYMBOLS



Digital print



Lightness



Easy transport



Fireproof material



Breathable fabric



UV protection



Fireproof material available



Water repellent material



Insulating material



Machine washable



Recycled



Certified



elleerre[®]
Dove c'è passione

FLYING BANNERS

- ◆ **Easy-Flag**
 - ◆ CLASSIC
 - ◆ DROP
 - ◆ MINI
 - ◆ TABLE
 - ◆ BASE PLATES AND ACCESSORIES
- ◆ MARKING FLAG
- ◆ SUPPORTER FLAG

Available in four sizes in the classic "knife" shape, they can be mounted and dismantled very quickly. The flag kit, enclosed in a strong polyester bag with zip, includes the screw ideal to fix the flag in soft ground such as grass, snow, sand and soil. Various metal bases are available, studied for different uses and fit for solid surfaces as concrete and asphalt. You can also order just the flag.

- Large and small quantities
- Anodized aluminium structure
- Spring steel flexible tip

- Quick and easy to assemble
- Packaging designed for easy storage
- Customized flag

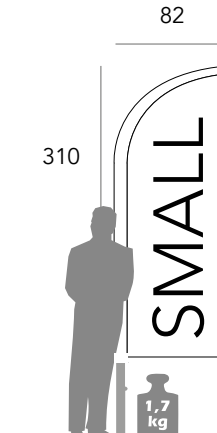
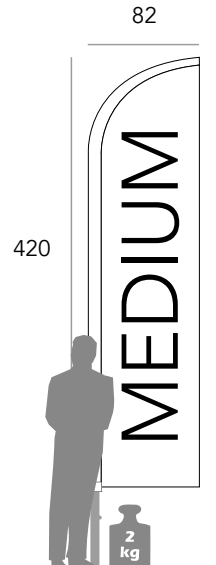
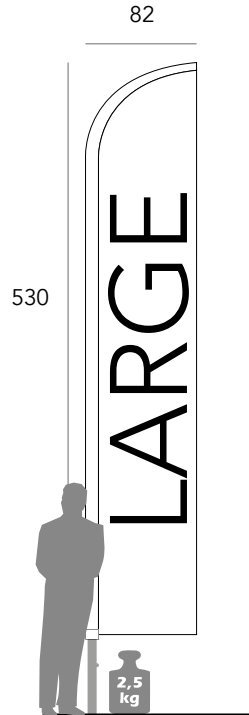
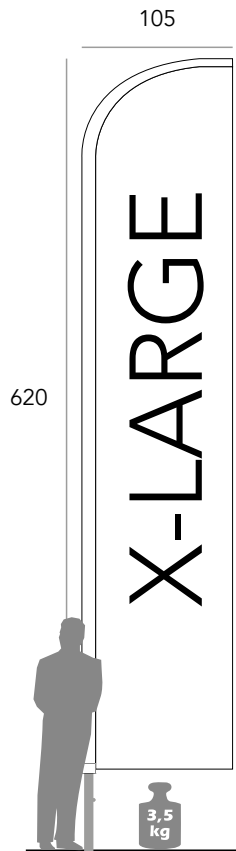
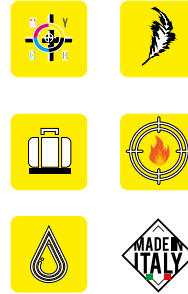

The Easy-Flag Drop is a flag with the same features of the classic one but with a "drop shaped" flag, 100% made of polyester. Its complete kit is delivered in a strong polyester bag with a zip including the screw to fix it on soft grounds, advertising flag, anodized aluminium poles and flexible spring steel tip. Thanks to its structure it stays perfectly tight even with no wind. You can also order just the flag.

- Easy and quick to assemble
- Customized flag

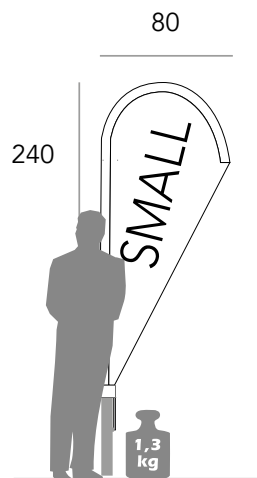
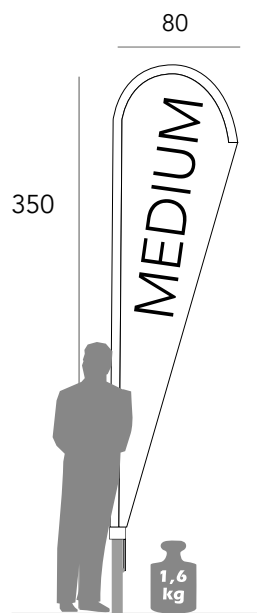
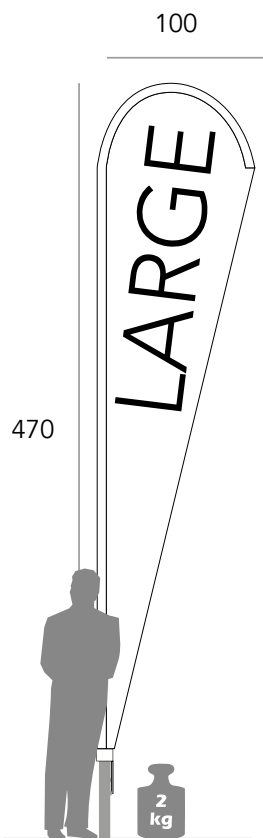

The Easy-Flag Square is a promotional flag with a squared design that retains the same sturdy structure as the Classic version, offering a more contemporary look. Made from 100% polyester, it is supplied as a complete kit in a practical and durable polyester zippered carry bag. The set includes: ground screw anchor for soft soil, printed flag and anodized aluminum poles. Thanks to its rectangular structure, the sail remains perfectly tensioned even in the absence of wind, ensuring maximum visibility and a consistently strong visual impact

- Easy and quick to assemble
- Easy to transport
- Lightweight
- Customized flag
- Digital printing

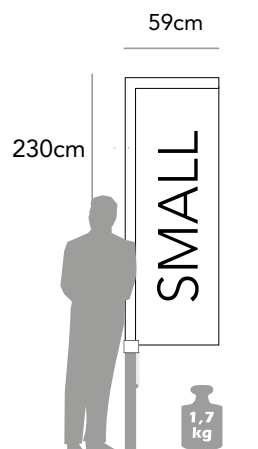
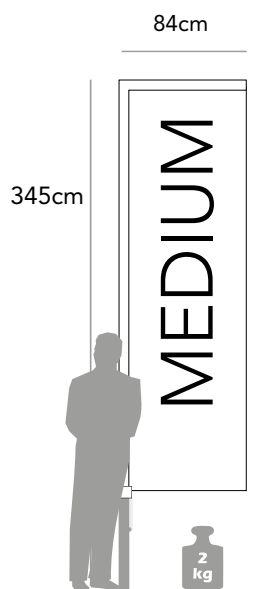
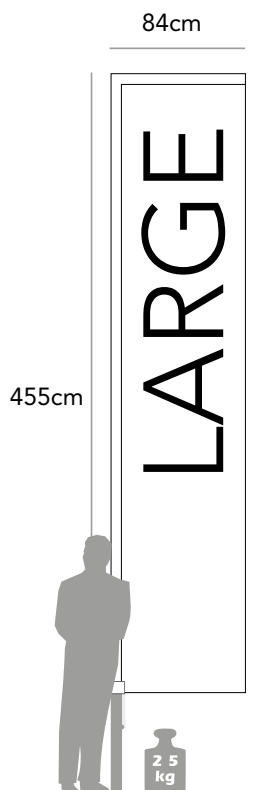
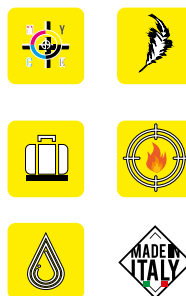

Iron base



"cross-shaped" iron base, fits all the surfaces

20 Kg concrete base



20 Kg. concrete base, plastic coated

Additional ballast



Additional ballast to be filled with water or sand

Base for cars



Base for cars, ideal for cars with decentralized support

40x40cm metal base



40x40 cm metal base, suitable for hard surfaces such as concrete, asphalt, soil and floors

Kit 2 Flag holder Easy-Flag



Kit 2 flag holder Easy-Flag to be installed to the PRO Gazebo 40 mm frame

XL fixer H. 60 cm



XL fixer, specific for big-sized Easy-Flags

Easy-Flag Full Kit

Easy-Flag full kit includes:

- . **Transportation bag**
- . **Fixer**
- . **Aluminium poles** (frame)
- . **Flag**



Easy-Flag Mini is designed to advertise your brand in a shop or shopping corner. The high-quality materials ensure an easy assembly, handling, high stability and durability. It is delivered in a one-box complete kit including base, aluminium pole, harmonic steel tip, polished metal base. Graphic and colours are fully customizable. We provide digital printing for small quantities and serigraphic printing for big quantities.

- . Large and small quantities
- . Quick and easy to assembly
- . Iron base

- . Aluminium pole
- . Flexible fiberglass tip
- . Customizable flag



CLASSIC

42

DROP

66

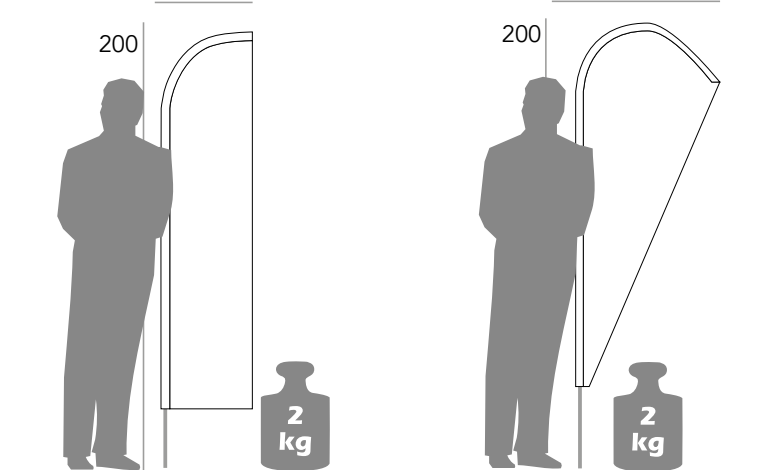

ALWAYS HOOK with the carabiner to keep the flag tension!

Easy-Flag Mini Full Kit

Easy-Flag Mini full kit includes:



- . Base plate
- . Aluminium poles (frame)
- . Flag
- . Screws and allen key

SPEAKING BOX



Easy-Flag Table is the table flag which gives visibility to your brand in an elegant and unusual way. Ideal for shops and fairs. Fully customizable and without colours limits. Flag made of polyester. Available in a one-box complete kit with polished metal base, fiberglass pole.

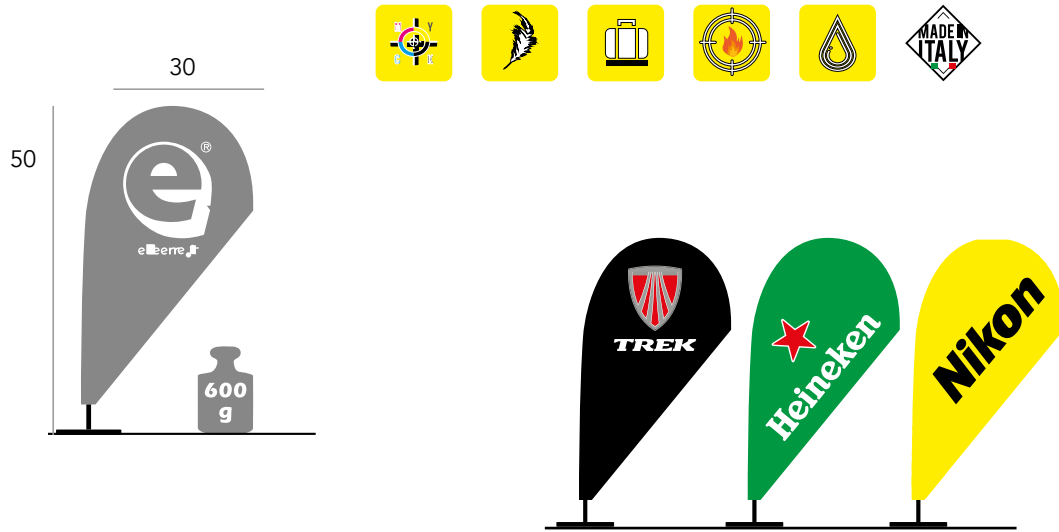

Easy-Flag Table Full Kit

Easy-Flag Table full kit includes

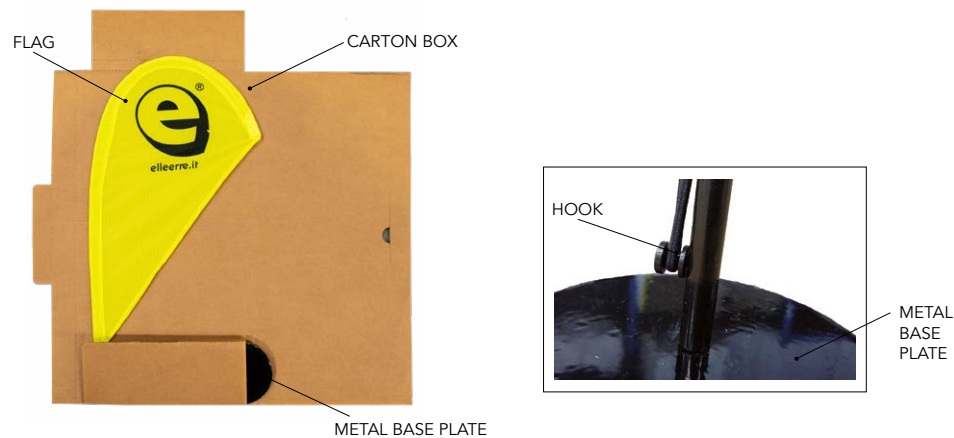

Marking flags are an indispensable tool for every outdoor event. Delimiting several areas of the race and marking the path is paramount for the safety. For this reason ElleErre has designed and realized this versatile marking flagship, easy to position and fully customizable.

- Standard size 25 x 33 cm
- Wood pole



HIGH-VISIBILITY FLAGS

The high-visibility marking flags are essential for night events and competitions. Marking the route when it is dark is a matter of safety. For this reason ElleErre has realized this versatile, fully customizable, easy-to-install flag, with an high-visibility section.

- Digital printing
 - High-visibility section
-
- Nautical polyester fabric
 - Beech wood striped
-
- Standard size 25 x 33 cm
 - Customizable dimensions



CAR FLAG

ElleErre car flags are designed to be fitted directly out of the window, drawing the attention and curiosity of those who see them. Car flags are the best way to promote your brand during car track events.



- Digital printing
- Nautical polyester fabric
- Plastic car holder
- Standard size 25 x 33 cm

Plastic car holder



SUPPORTERS' FLAG

The supporters' flags during sport events are an exceptional tool for visibility. Flags for fans and supporters are designed to root for relatives and friends. Swinging at the passage of athletes or on arrival is always fun for adults and children. Made with European flag-making high grade nautical polyester, a 100% recyclable material, which ensures excellent printing quality and durability over time.

- Digital printing
- Nautical polyester fabric
- Wooden pole
- Standard size 20 x 30 cm



elleerre®
Dove c'è passione

Easy-Gazebo

◆ Easy-Gazebo LIGHT

◆ Easy-Gazebo PRO



Easy-Gazebo PRO has an aluminium structure, while the roof and sidewalls are digital printed and fully customizable. The Class 1-certified fabric is waterproof and fireproof, making all ElleErre gazebos suitable also for indoor use.

The roof, the pelmets and the sidewalls are available in a range of neutral colours, without customization (Mod. STANDARD), while the version Roof Easy-Gazebo can be fully customized with no limits for colours or graphics. It is also possible to print high definition pictures on the sidewalls and the roof, with no additional costs.

In the measures 3x3 m e 3x4,5 m, the frame Easy-Gazebo Light is also available with hexagonal aluminium structure poles, which are lighter and cheaper. Both the PRO and LIGHT structures can be folded and opened in a few seconds, allowing a quick installation.

These gazebos are delivered with rods, anchoring pegs and wheeled carry-on case for an easy transport. Spare parts and accessories are available, such as extra metal ballasts, sidewalls with doors and windows which can be produced upon customer request.



Easy-Gazebo
with thermo-taping:
even more resistant to water!



FRAMES

LIGHT STRUCTURE

LIGHT STRUCTURE / EASY TO HANDLE

Made with hexagonal aluminium profiles, 45 mm/0,8 mm thick.
A strong and lightweight gazebo, easy to transport, it is delivered with pegs in a wheeled carry case on wheels



PRO STRUCTURE

STRONG / DURABLE / SOLID

The best structure available on the market.
Made with 40x40 mm/2,0 mm thick aluminium profiles, it is suitable for a professional and constant use, ideal for a frequent use. Built with stainless steel screws and extruded aluminium junctions. It is delivered with pegs in a wheeled carry case on wheels



SIZE AND DIMENSIONS

2x2 m	3x3 m	3x4,5 m	4x4 m	6x3 m	8x4 m
Weight: 28 kg	Weight Pro: 36 kg Weight Light: 26 kg	Weight Pro: 46 kg Weight Light: 34 kg	Weight: 44 kg	Weight: 59 kg	Weight: 68 kg
Dimensions closed: 152x27x27	Dimensions closed: 152x27x27	Dimensions closed: 152x37x27	Dimensions closed: 202x27x27	Dimensions closed: 152x48x27	Dimensions closed: 202x50x27
Top height: 2,98 mt	Top height: 3,28 mt	Top height: 3,30 mt	Top height: 3,87 mt	Top height: 3,28 mt	Top height: 3,87 mt

ACCESSORIES

Kit 2 Flag holder Easy-Flag



Kit 2 Flag holder Easy-Flag to be fixed to the PRO Gazebo 40 mm frame

Weight 15,5 kg for gazebo



Base plate for Pro and Light frames

Kit 2 Couplers



Kit 2 x Couplers terminals for gazebo PRO frames (40mm)









Gutter





Gutter for gazebos in a row.

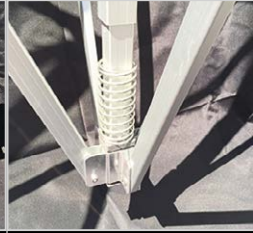

TECHNICAL SPECIFICATIONS OF THE STRUCTURES

	STRUCTURE SECTION	FRAME	TUBE PROFILE	AVAILABLE SIZES	CONNECTION BARS	JOINT FIXING	SPRING TENSIONER	SCREWS	JOINTS	BASE FOOT
LIGHT	45MM / HEXAGONAL TELESCOPIC PILES THICKNESS 0.8 MM		Aluminum 45x40 HEX / 0,8 mm thickness	Square 3X3 Rectangular 3x4,5	25x12,5mm Aluminum	PRS / Pull Ring System	Spring ø 30mm	Stainless steel	Nylon	Steel
										
PRO	40MM / SQUARES TELESCOPIC POLES THICKNESS 2 MM		Aluminum reinforcement Section 40x40 / 2 mm thickness	Square 2x2 / 3x3 / 4x4 Rectangular 3x4.5 / 3x6 / 4x8	32x16mm Aluminum reinforcement	PRS / Pull Ring System	Spring ø 60mm	Stainless steel	Extruded Aluminum	Galvanized steel Aluminum
										

TECHNICAL SPECIFICATIONS OF ROOF AND WALLS

	FABRIC	CUSTOMIZATION
NOT CUSTOMIZED	Certified Fireproof Nylon - Tinto 200gr / m2	  Black White
CUSTOM	Class 1 Fireproof Polyester - one-sided 250gr / m2	Colours and graphics are fully customizable – digital printed High resolution photographic images 150 dpi



elleerre®
Dove c'è passione

BANNERS

- ◆ TNT DIGITAL PRINTING
- ◆ TNT SERIGRAPHIC PRINTING
- ◆ MESH BANNERS

Practical, efficient and economical, the TNT nonstop unit banners are ideal to be employed at sporting events and on any other occasion. They can be delivered in rolls or in single units with or without PVC reinforced installation eyelets. The digital printing is employed for small quantities and complex graphics, while for big quantities we prefer the serigraphy, achieving the best value for money.

ROLL



- Digital or serigraphic printing
- endless possibilities of use outdoors and indoors
- Lightweight
- cost transportation

- Finishing possibilities:
 - roll
 - roll with eyelets
 - single banners with eyelets

- Easy to hook the banners to the structures (poles, gates, barriers...)
- Available in the standard size (height 80 o 100 cm) or customizable size (up to 160 cm and beyond) according to the customer's needs

- The quality of printing allows to print both simple logos and high definition photographs



Accesorios

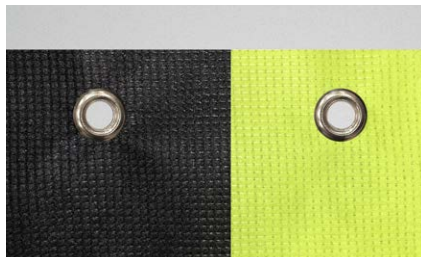

EYELETS WITHOUT REINFORCEMENT

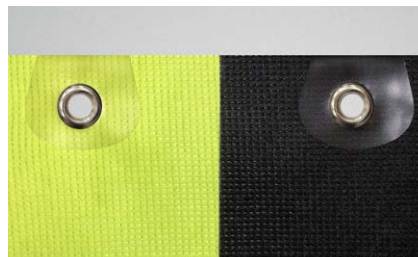

EYELETS WITH REINFORCEMENT

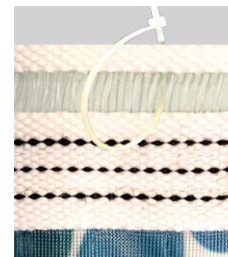

MULTI-COLORED BAND



TNT BANNERS/DIGITAL PRINTING

Digital printing is to be used for graphics with a wide range of colours and shades and it should be preferred for smaller quantities. The result is a high definition printing with bright colours, uniform shades and sharp details.

- Best quality for complex pictures and drawings
- Possibility to duplicate any graphics with no colour limit
- Suitable for the production of small quantities
- Printing without loom

HEIGHT

- h.80cm - Standard
- h.100cm - Oversize

TNT BANNERS/ SERIGRAPHIC PRINTING

The serigraphic printing is to be preferred for larger quantities, it is suitable for printing plain colour graphics, with clearly defined outlines and colours.

To obtain a serigraphic print a printing loom has to be set up, allowing the ink layers to filter (one colour at a time) from the loom to the surface.

- Economical for average and large quantities
- High quality for logos and graphics

HEIGHT

- h.80cm - Standard
- h.100cm - Oversize



Digital printing.

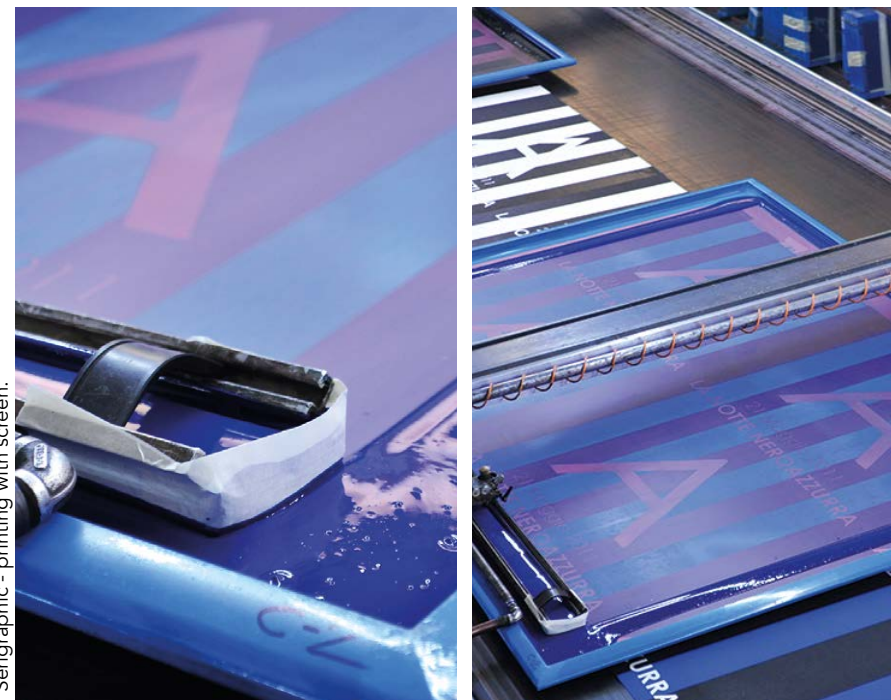

Serigraphic - printing with screen.

Practical, effective and economic windbreakers made of polyester, ideal to be used during events. They can be supplied in rolls or in single units, with or without PVC reinforced fixing eyelets.



- The printing can be digital
- Endless possibilities of employ outdoors and indoors
- Lightweight
- Low cost transport

- Finishing possibilities:
- roll
 - roll with eyelets
 - single units with eyelets

- Easy to hook to structures (poles, gates, barriers...)
- Available in the standard size (height 80 o 100 cm) or customizable size (up to 160 cm and beyond) according to the customer's needs
- The quality of printing allows to print both simple logos and high definition photographs



Accessories

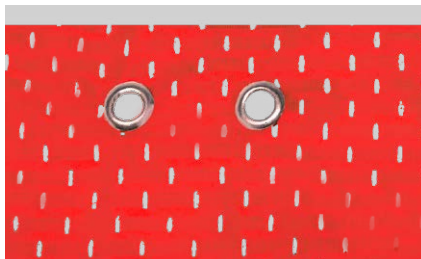

EYELETS WITHOUT REINFORCEMENT

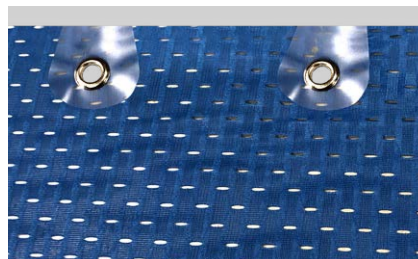

EYELETS WITH REINFORCEMENT

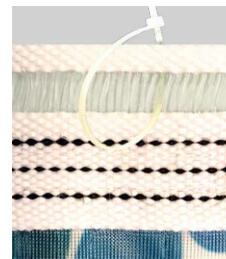

MULTI-COLORED BAND



Digital printing is to be used for graphics with a wide range of colours and shades and it should be preferred for smaller quantities. The result is a high definition printing with bright colours, uniform shades and sharp details.

- Best quality for complex pictures and drawings
- Possibility to duplicate any graphics with no colour limits
- Suitable for the production of small quantities
- Printing without loom





elleerre®
Dove c'è passione

Easy-Relax

- ◆ CUBE
- ◆ G-CUBE
- ◆ TUBE
- ◆ PEAR
- ◆ SAK
- ◆ DESK
- ◆ SOFÀ

The Easy-Relax line has been created to offer relax areas during your events. Adaptable, fully customizable, the Easy-Relax line is printed on waterproof and fireproof class 1 polyester fabric. All the products of the Easy-Relax line can be used both indoors and outdoors. The Easy-Relax Cube is perfect as a seating as well as a piece of furniture in your shop or point of sale. Available both in smaller and larger quantities.

- Comfortable and handy cube 40 cm x 40 cm x 46 cm, weight 2,6 Kg
 - Excellent brand visibility
 - Digital printing
-
- Class 1 waterproof and fireproof fabric on the outside
 - Polystyrene microspheres inside
-
- Ideal for outdoors and indoors
 - Printing on five sides, black background
 - 100% polyester fabric

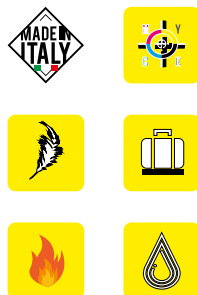

The Easy-Relax line has been designed to offer relax areas during your event. The Easy-Relax G-Cube is the brand new, fully customizable pouf with a cozy rigid foam padding, that ensure the pouf to get back in shape after every usage. The seat is stable and comfortable and the design can be customized with all kind of photos, illustrations, logos and graphics. The fabric used for the Easy-Relax G-Cube makes it ideal for events, fairs, indoor events and usage in shopping centres.

- Comfortable and handy 45 cm x 45 cm x 45 cm, weight 1,7 Kg
 - Excellent visibility of the brand
 - Digital printing
-
- Digital printing
 - Foam interior
-
- Removable and washable
 - Ideal for outdoors and indoors
 - Printing on five sides, black background

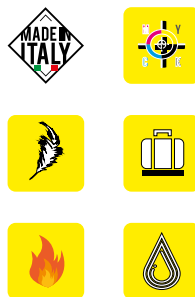

The Easy-Relax line is completed by a new product, ideal to decorate stands, conference areas and relax areas: the G-Cube sofa, a fully customizable soft bench.

The rigid foam padding on the inside and removable and washable elastic fabric on the outside make this sofa the ideal piece of furniture for various events na doccasion, such as conferences, shops, fairs, shopping centres and much more.

- Comfortable and handy 44 cm x 135 cm x 44 cm
 - Excellent visibility of the brand
 - Digital printing
-
- Foam interior
 - Removable and washable
-
- Ideal for outdoors and indoors
 - Printing on five sides, black background

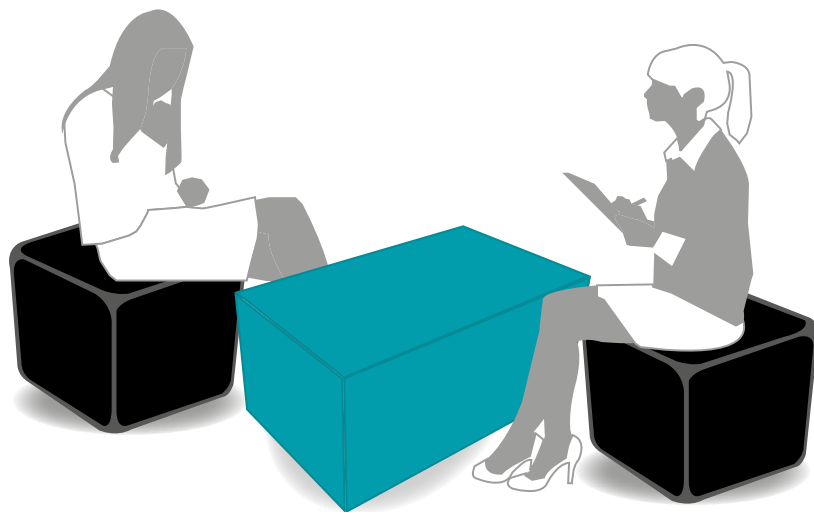

The Easy-Relax Tube is the cylinder-shaped pouf to decorate shops and point of sale. It is available in smaller and larger quantities and is fully customizable (no limits of graphics or colours).

The waterproof and fireproof class 1 polyester fabric makes it ideal both for indoor and outdoor usage.

- Comfortable and practical cylinders ø 47 cm / h.46 cm
 - Digital printing
 - Class 1 waterproof and fireproof polyester fabric
-
- Polystyrene microspheres inside
 - Ideal for outdoors and indoors
 - Customizable seat and sides
 - Black base



Easy-Relax Pear is an original furnishing accessory and it is ideal as a seat in shops and sale points. It can be produced in large or small quantities. Fully customizable with no limits of graphics or colours, it is printed on waterproof and fireproof class 1 polyester fabric. All the products of the Easy-Relax line can be used both indoors and outdoors.

- Comfortable and handy pear base Ø 67x90 cm, weight 4 Kg
- Polystyrene microspheres inside
- Ideal for outdoors and indoors
- Can be customized on six sides

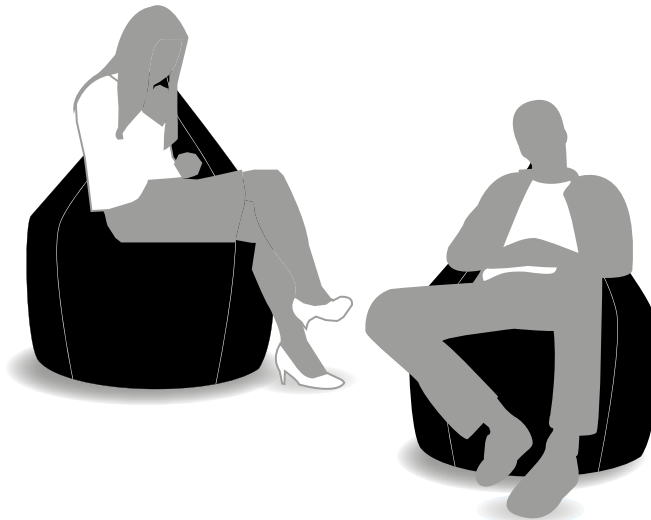
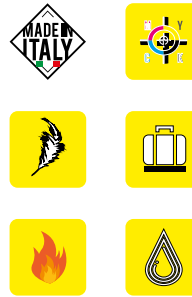

The Easy-Relax line has been created to offer relax areas during your events. Fully customizable with no limits of graphics or colours, all the Easy-Relax products are printed on waterproof and fireproof class 1 polyester fabric, making them ideal for both indoor and outdoor use.

- Comfortable and practical rectangular sacks 155 cm x 140 cm, weight 6,5 kg
- Polystyrene microspheres inside
- Ideal for outdoors and indoors
- Can be customized on two sides

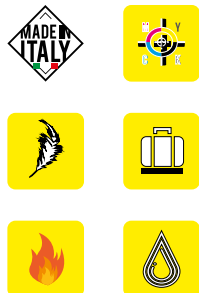

The Desk completes the Easy-Relax line: perfect for events, shows and fairs, it is a great way to promote your brand, adaptable and functional at the same time. It is made of 100% certified fireproof polyester, therefore it is suitable also for public events and fairs. The desk is printed on five sides with digital technology, with no limits of customization as far as for colours, graphics or pictures. The fabric is waterproof, fireproof and filled with polystyrene microspheres. On the inside of the top side a wooden board enables to use it as a proper desk.

The features of the fabric make this product suitable both for indoor and outdoor use. All the products of the Easy-Relax line can be used both indoors and outdoors.

- Comfortable and handy desk: 40 cm x 80 cm x 46 cm
- Excellent brand visibility
- Class 1 waterproof and fireproof polyester fabric
- Ideal for indoors and outdoors
- Filled with polystyrene, has a hard top side

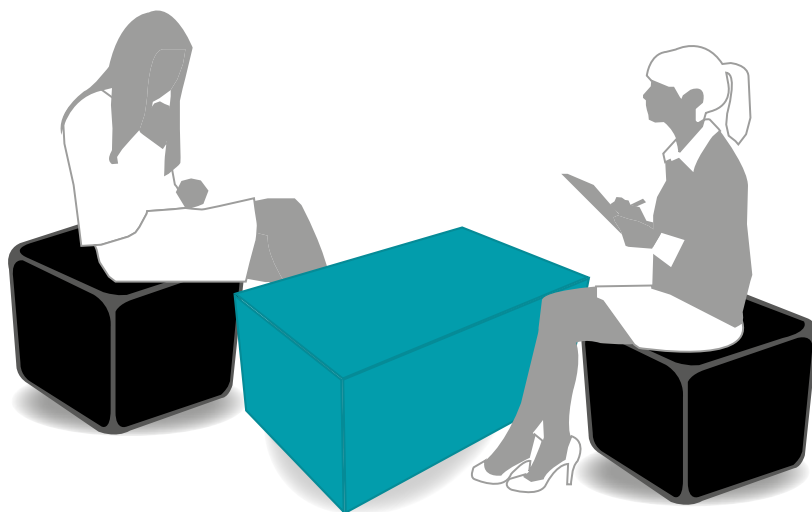

Easy-Relax is a versatile and comfortable seating solution, ideal for any type of event. Its practical design and high visibility make it perfect for any setting, whether indoor or outdoor.

Made from flame-retardant fabric and filled with expanded polystyrene microspheres, the sofa can be fully customized with unlimited colors, graphics, and photographs.



- 100% polyester fabric
- Fully customizable graphics
- Class 1 waterproof and fireproof exterior fabric
- Polystyrene microspheres filling
- Ideal for both outdoor and indoor use
- Available in two sizes:
 - 1 seat (h.70x75x90 cm, weight 6 Kg)
 - 2 seats (h.70x120x90 cm, weight 12 Kg)



elleerre[®]
Dove c'è passione

INFLATABLES

- ◆ ARCH
- ◆ HOUSE
- ◆ CROSSING ARCHES
- ◆ CYLINDER
- ◆ BALLOON



ElleErre produces advertising inflatable to make your event exclusive. The inflatables can be customized in shape, colour and size. They are printed on certified waterproof and fireproof polyester. It is possible to print any graphic or picture directly on the structure with no limits of colours. It is also possible to install your banner/logos through the fixing velcro stripes available on standard colour arches. The silent electrical powered engine incorporated in the structure and continuously pumps air into the inflatables, keeping them perfectly tight.

Inflatable arch made of Class1 fireproof polyester, with aeronautic seams, together with anchoring ropes, optional Velcro to fix the banners (arch without customizing), fan and bag.

- Different shapes and sizes
- 100% customizing
- Silent engine
- Automatic and quick assemblage



	ARCH 7 m	ARCH 9 m	ARCH 10 m	ARCH 13 m	ARCH 14 m
Tech	Valori				
External width	7 m	9 m	10 m	13 m	14 m
Internal width	5 m	7 m	7 m	10 m	10 m
Internal height	3,5 m	4,5 m	4,5 m	5 m	5 m
Diameter pipe	1 m	1 m	1,5 m	1,5 m	2 m
Weight	22 kg	29 kg	37 kg	39 kg	46 kg
Power source	220 Volt	220 Volt	220 Volt	220 Volt	220 Volt
Power HP	0,15 HP	0,25 HP	0,25 HP	0,50 HP	0,75 HP

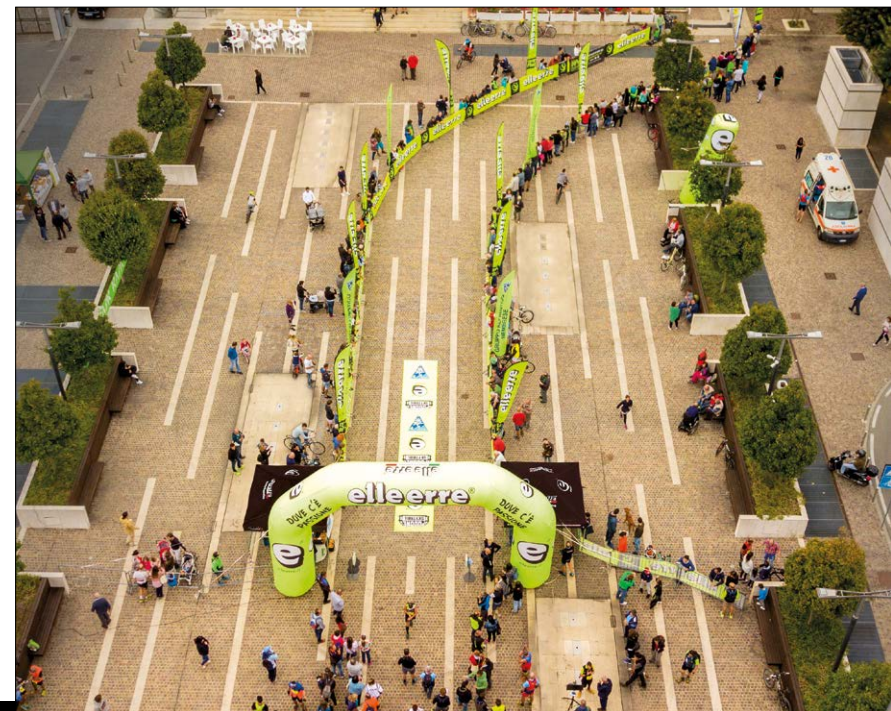

The standard color arch allows banners and logos to be applied quickly and easily thanks to a practical Velcro system. This solution makes it possible to update the customization whenever needed, without replacing the entire inflatable advertising structure, ensuring significant savings in both costs and materials.

The motor, silent and integrated into the structure, is designed to operate with a continuous power supply. By constantly channeling air inside the inflatable, it ensures optimal tension and perfect stability during use.

The inflatable arch, made of Class 1 fireproof polyester and finished with aeronautic seams to ensure maximum strength and durability, is supplied as a complete kit. The set includes anchoring ropes, an internal fan, a Velcro system for banner application, and a practical carrying bag for easy and immediate use.



- Interchangeable custom banners
- Silent motor
- Quick and easy setup

	ARCO 7 M	ARCO 9 M	ARCO 10 M	ARCO 13 M	ARCO 14 M
Specifiche	Valori				
External width	7 m	9 m	10 m	13 m	14 m
Internal width	5 m	7 m	7 m	10 m	10 m
Internal height	3,5 m	4,5 m	4,5 m	5 m	5 m
Diameter pipe	1 m	1 m	1,5 m	1,5 m	2 m
Weight	22 kg	29 kg	37 kg	39 kg	46 kg
Power source	220 Volt	220 Volt	220 Volt	220 Volt	220 Volt
Power HP	0,15 cv.	0,25 cv.	0,25 cv.	0,50 cv.	0,75 cv.
Horizontal banner size	h.142x250 cm	h.142x400 cm	h.145x450 cm	h.145x600 cm	h.148x600 cm
Oblique banner size	h.142x142 cm	h.142x200 cm	h.145x180 cm	h.145x250 cm	h.148x250 cm
Vertical banner size	h.142x142 cm	h.200x142 cm	h.180x145 cm	h.250x145 cm	h.250x148 cm

STANDARD COLORS:

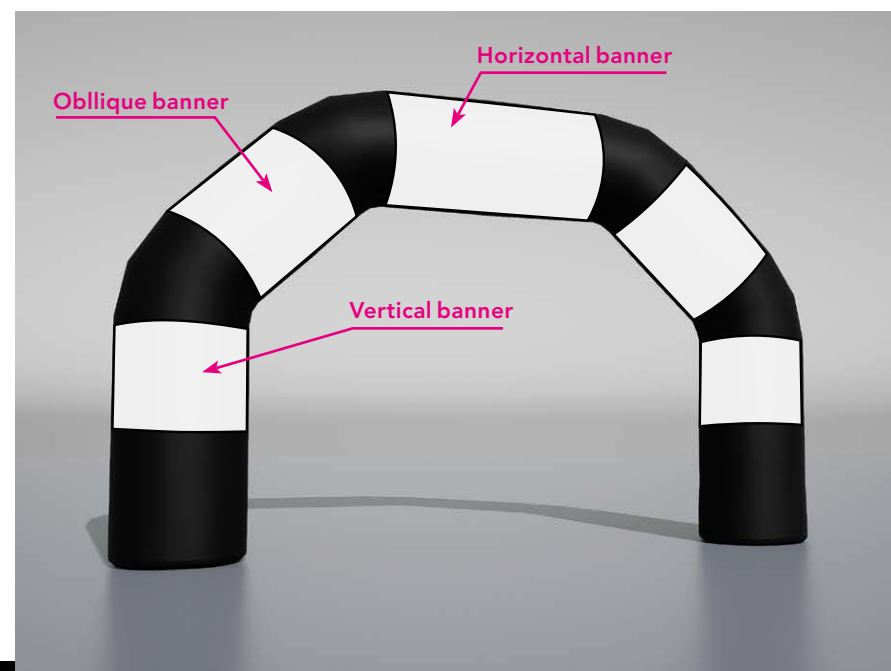

Inflatable house-shaped stands made of Class1 fireproof polyester fabric, with aeronautic seams, customization with digital printing, delivered with anchoring ropes, fan and bag.

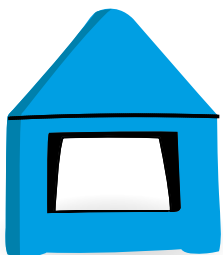

INFLATABLE HOUSE		
	4x4 mt	5x5 mt
Tech		
External width	4x4 mt	5x5 mt
Height	4,5 mt	5 mt
Weight	30 kg	42 kg
Power source	220 Volt	220 Volt
Power HP	0,25 HP	0,75 HP

Model
1 Color
Fully customizable

STANDARD COLORS:



Inflatable stand shaped as two crossing arches made of Class1 fireproof polyester fabric, with aeronautic seams, customization with digital printing, delivered with anchoring ropes, fan and bag.

INFLATABLE CROSSING ARCHES			
	4,5x4,5 mt	5,5x5,5 mt	6,5x6,5 mt
Tech		Valori	
External width	4,5x4,5 mt	5,5x5,5 mt	6,5x6,5 mt
Height	3,5 mt	4,5 mt	5 mt
Weight	23 kg	29 kg	35 kg
Power source	220 Volt	220 Volt	220 Volt
Power HP	0,15 HP	0,25 HP	0,25 HP

Model
1 Color
Fully customizable

Complements
Lighting
4 printed awnings
4 printed walls



Cylinder-shaped inflatable, available in different sizes. Made of Class1 fireproof polyester fabric, with aeronautic seams, customization with digital printing, delivered with anchoring ropes, fan and bag.

INFLATABLES CYLINDER			
	3 mt	4 mt	5 mt
Tech			
Height	3 mt	4 mt	5 mt
Diameter	0,92 mt	0,92 mt	1,4 mt
Power source	220 Volt	220 Volt	220 Volt
Power HP	0,15 HP	0,15 HP	0,15 HP

Model
Fully customizable
1 Color
Printed banners 2pc

Accessory
Base plate
Internal light

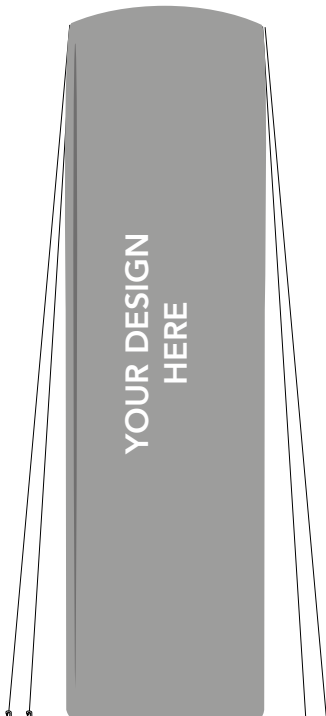

STANDARD COLORS:

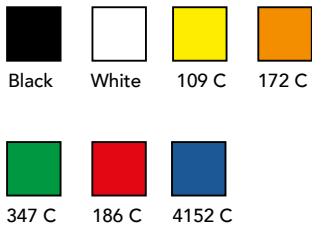

Balloon-shaped inflatable, available in different sizes. Made of Class1 fireproof polyester fabric, with aeronautic seams, customization with digital printing, delivered with anchoring ropes, velcro for banner installation, fan and bag.

INFLATABLES BALLOON				
	5 mt	6 mt	7 mt	8 mt
Tech				
Height	5 mt	6 mt	7 mt	8 mt
Diameter	3 mt	4 mt	5 mt	6 mt
Weight	25 kg	29 kg	39 kg	46 kg
Frame	Polyester fireproof ripstop	Polyester fireproof ripstop	Polyester fireproof ripstop	Polyester fireproof ripstop
Power source	Volt 220	Volt 220	Volt 220	Volt 220
Power HP	0,15 HP	0,25 HP	0,25 HP	0,50 HP
Light	250 Watt	250 Watt	500 Watt	500 Watt
Printing space	9,6x1,45 mt.	12x1,45 mt.	14,8x1,45 mt.	18x1,45 mt.

Model
Fully customizable

Complements
Internal light

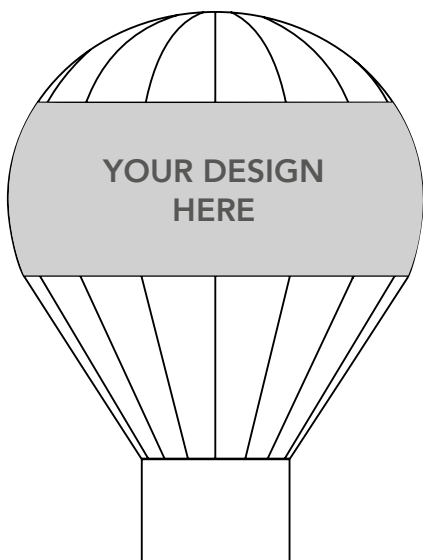

elleerre[®]
Dove c'è passione

EASY GLOO - INFLATABLE TENT



The Inflatable Tent is suitable for all outdoor events, in order to create a truly unique exhibition space. The lightweight professional structure has four inflatable legs that provide exceptional stability. Quick and easy to assemble, it inflates quickly thanks to the help of an electric pump.

The structure is equipped with over pressure valves that automatically release the air in excess when the optimal pressure is reached.

The whole series of inflatable tents are composed of strong zippers, indispensable for mounting walls to the roof and all accessories can be removed without changing the structure.

High quality fabric is waterproof and fireproof.

The Inflatable Tent is completely customizable through high quality digital printing. Accessories are available such as specific sandbag for all sizes, lights, steel pins and walls with doors and windows that can be customized on customer request



DIMENSIONS AND SIZE

3x3 m

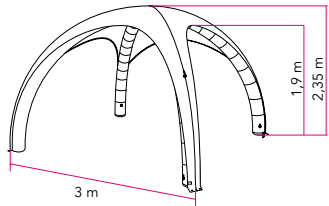

m²: 9

Overall Height: 2,35 m

Clearance Height: 1,9 m

Frame, Roof and carry case Weight: 11,5 Kg

Frame Profile Diameter: 20 cm

4x4 m

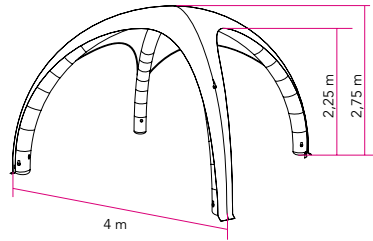

m²: 16

Overall Height: 2,75 m

Clearance Height: 2,25 m

Frame, Roof and carry case Weight: 15,5 Kg

Frame Profile Diameter: 26 cm

5x5 m

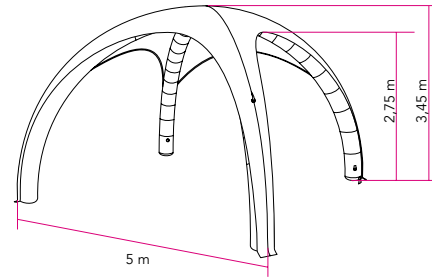

m²: 25

Overall Height: 3,45 m

Clearance Height: 2,75 m

Frame, Roof and carry case Weight: 20,5 Kg

Frame Profile Diameter: 33 cm

6x6

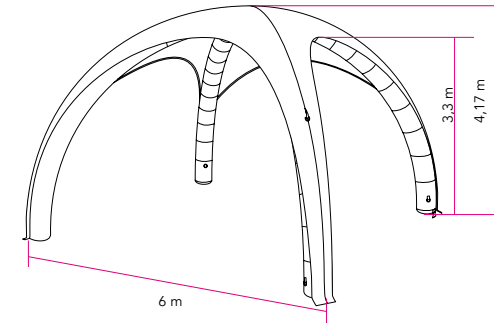

m²: 36

Overall Height: 4,17 m

Clearance Height: 3,4 m

Frame, Roof and carry case Weight: 29 Kg

Frame Profile Diameter: 40 cm

Frame Material: Dacron, 170 gr

Frame Colors: Black, White, Red, Blue, Yellow, Green, Grey, Orange



Roof Material: 600D polyester PU coating, 215 gsm

Fabric Feature: Waterproof, CPAI-84 Fire-retardant, UV-Protection



ACCESSORIES

Steel Pins



Suitable for fixing and giving more stability to the inflatable placed on grass.
Weight: 1,5 Kg.

Sandbag



Suitable to be filled

Electric Pump



Output: 1700V | Power: 1000W
Weight: 1.7kg | Packing: 25x23x19cm

Led Lights



Waterproof Led structure

Connection Tunnel



The connection tunnel is suitable for connecting two inflatable tent

MODULARLY EXPANDABLE

Full Wall

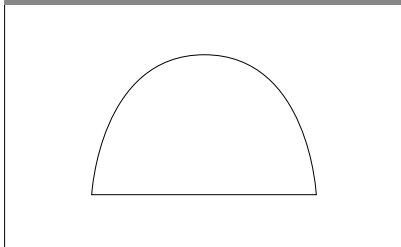

Window Wall

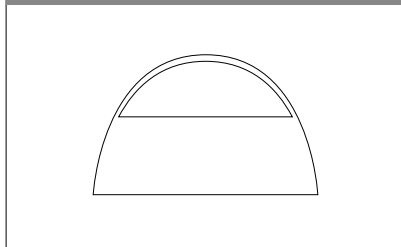

Roll-up Wall

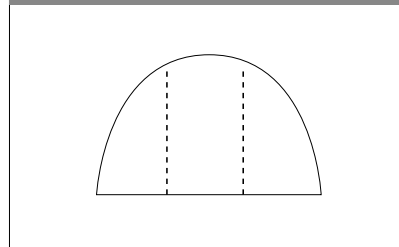

Awning

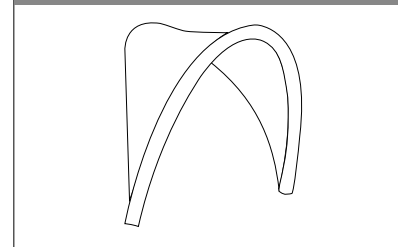

Awning Banner

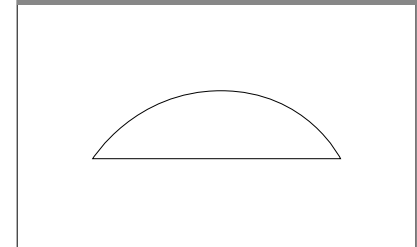

elleerre®
Dove c'è passione

OUTDOOR/INDOOR EVENTS

- ◆ RUBBER CARPET
- ◆ DOORMAT
- ◆ CHAIR
- ◆ ROLL-UP
- ◆ POLY BANNER
- ◆ SNOWBANNER
- ◆ WINDSOCK
- ◆ BEAN BANNER
- ◆ BACKDROP



Customized carpets are an unusual advertising display, suitable for fair stands, in shops or during sport events. Adherence to the ground and safety are ensured by the special rubber anti-slip backside.

- Maximum height 160 cm
- Polyester with anti-slip rubber backside
- Weight 850 g/mq
- Digital printing

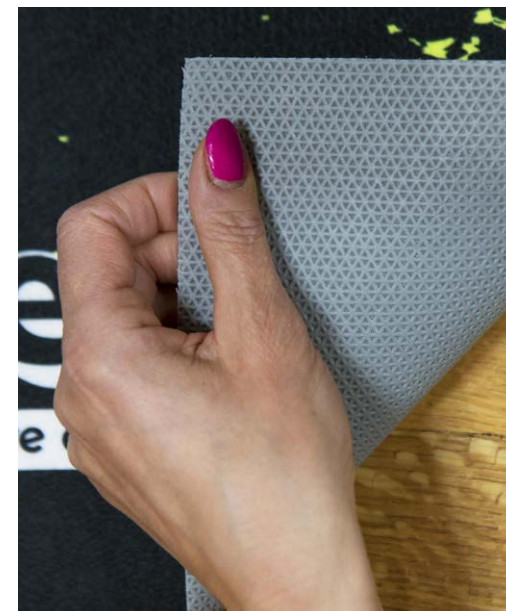

Also available: ElleErre Bike Training Mat: a non-slip, noise and vibrations reducing mat, that protects the floor from sweat and bike oil.



What a better way to welcome your customers and to create a strong visual impact than a customized doormat! Customized floor mats combine the utility of the product with the elegance of a piece of furniture. The doormats are inkjet-printed with a 4 mm thick PVC edge. All colours are available.

- PVC bottom and edge
- Weight 2400 g / sqm
- Thickness 4 mm
- Inkjet printing



The personalised fair desk is perfect for welcoming customers at the stand and attracting attention at a promotional corner. The ElleErre fair desk is light, quick and easy to assemble, does not require the use of additional tools and easy to transport. The ElleErre fair desk is customizable, ElleErre offers you the possibility to print the fabrics that covers it with your logo with your graphics.

- Custom cloth h.90x180cm, Desk size: h.93x91x48 cm
- Banquet with curved front, top and base
- Gray plastic drum
- Base and top available in black or birch
- Complete with custom fabric banner and transport bag

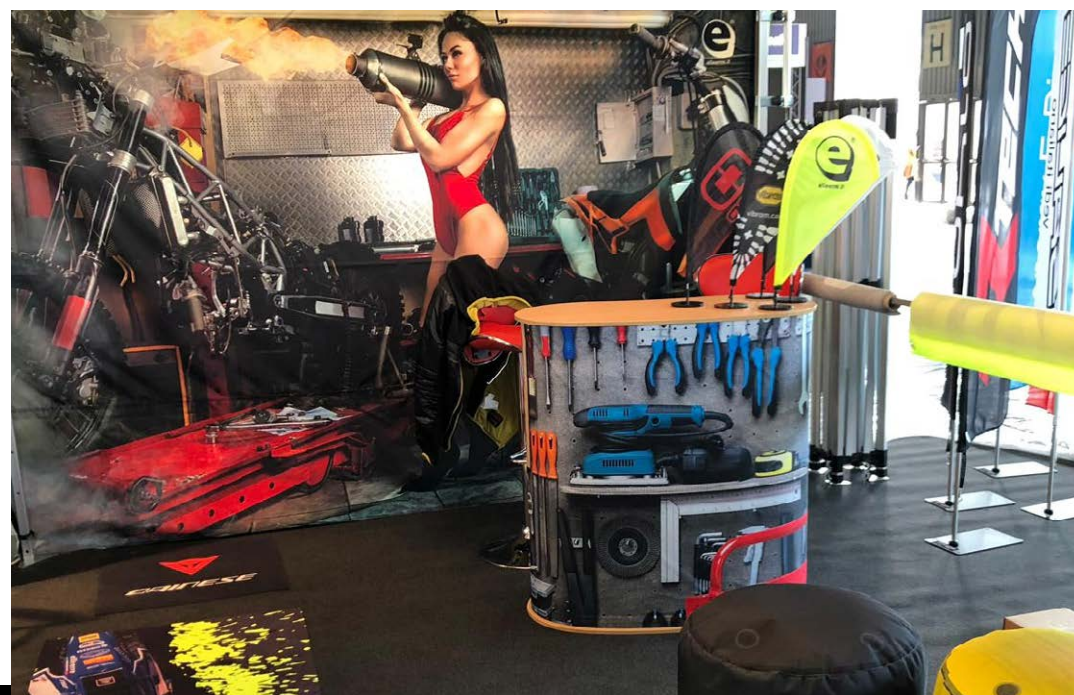

Customized aluminium folding chair (cm. 47x57x58) Padded back, seat and arms, printed on high quality waterproof and fireproof polyester fabric. Fully customizable digital printing.

- Aluminium frame
- Dimensions: 47 x 57 x 58
- Easy to carry
- Padded seat, arms and back
- Digital printing
- Class 1 waterproof and fireproof fabric
- Lightweight
- 100% customizable graphic

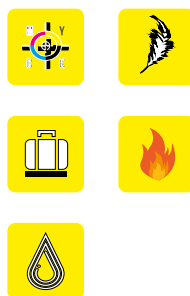

The folding wooden deck chair is ideal for events, beach resorts, and promotional spaces.

The backrest, adjustable to 3 positions, is fully customizable with high-definition digital printing on high-quality water-repellent and fire-retardant polyester fabric.

The printing technology ensures maximum creative freedom, with no limits on colors or graphics, delivering bright, long-lasting results.

- Easy to transport
- Customizable backrest: 42 x 119
- Class 1 waterproof and fireproof fabric
- Lightweight
- 100% graphic customizing
- Dimensions when folded: 56 x 131 cm.



The roll-up banner are advertising folding displays that can be used indoors and outdoors. They are frequently seen to promote products and services during meetings, workshops, fairs.

Roll-up aluminium structure, completed by the "EcoDisplay" polyester fireproof fully customizable fabric, and the carry bag.

Size:

h.200x80cm
h.200x100cm

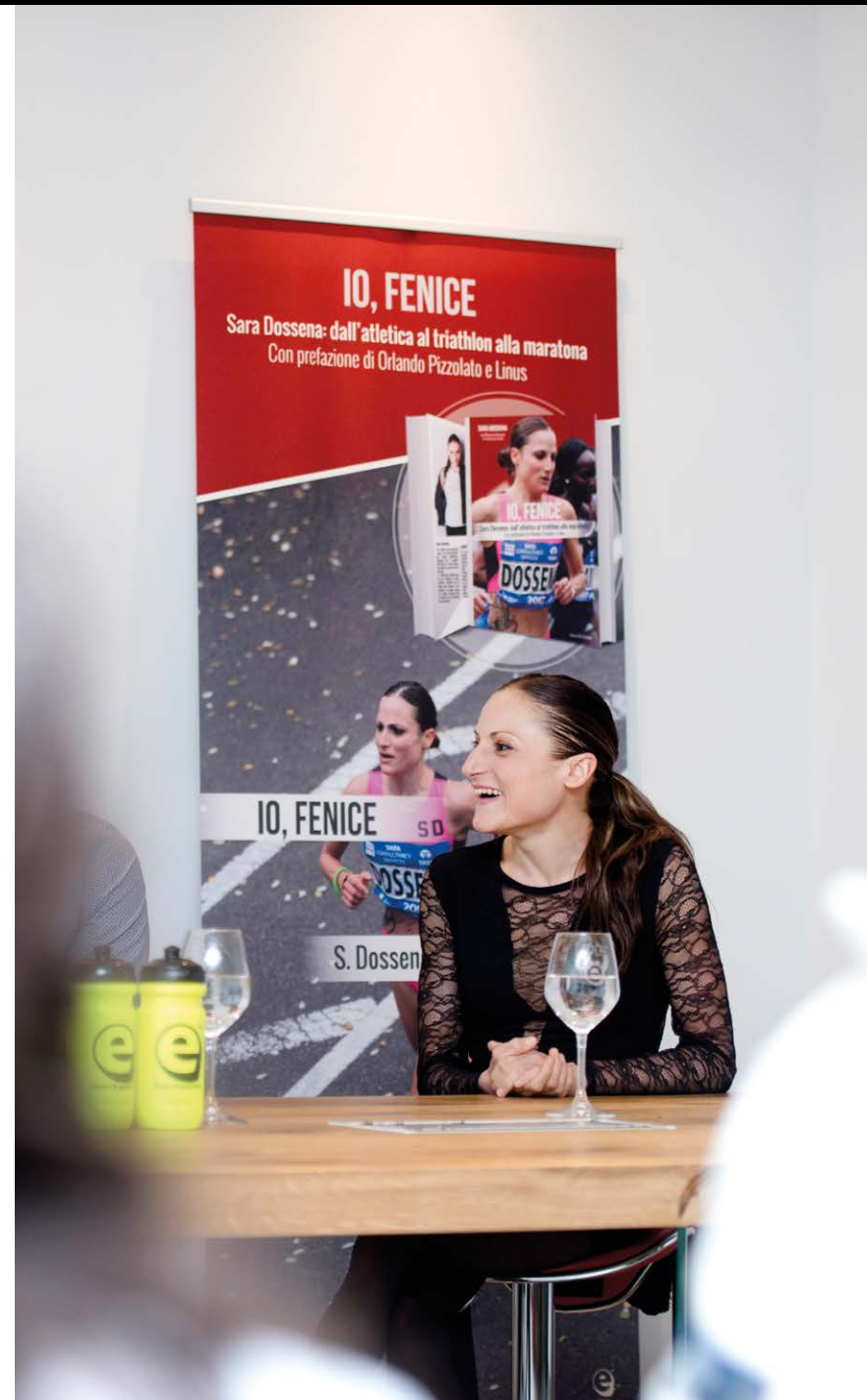
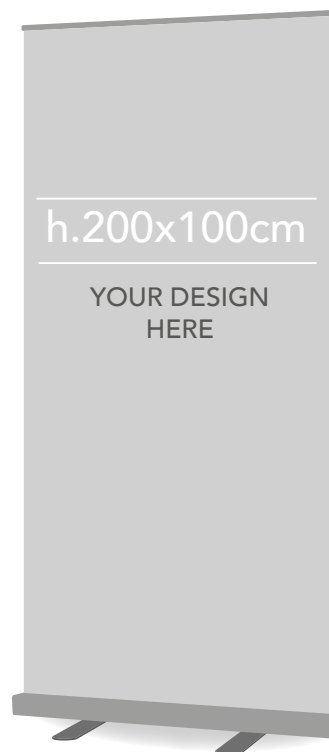
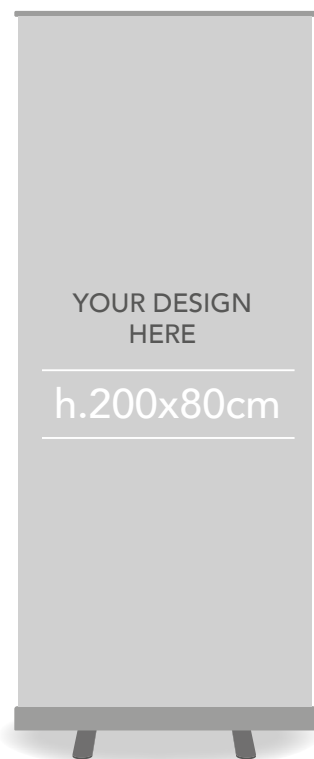

Polyethylene track tape used to delimit tracks in sporting events and races. In addition to the function of delimiting the tracks, the tape can be customized with your logo and your graphic (minimum quantity 75 rolls/400m each) acting as an ideal promotional medium. Height 10cm/ Thickness 80 micron Tapes with the ElleErre logo or neutral ones are also available at prompt delivery. Height 10 cm Thickness 80 micron.

- Polyethylene film
- Thickness variesn (from 60 to 100 micron)
- Available in different colours
- Height to be customized (standard 10 cm)



POLY-BANNER PERSONALIZED
h.10cm / 80 micron
SCREEN / to define based on design



POLY-BANNER STANDARD
h.10cm / 60 micron

COLOURS



POLY-BANNER ELLE-ERRE
h.10cm / 80 micron



BACKSTROKE FLAGS

Backstroke flags are an essential feature for all swimming pools hosting competitions, events, or lane swimming activities.

The flags feature high-quality custom printing and are sewn onto durable webbing to ensure stability and easy installation across the pool.

Available in various lengths and sizes, they adapt perfectly to different requirements. The customization option allows the inclusion of logos, corporate colors, and dedicated graphic elements.

The flags are printed on special 240-micron paper, selected for its high resistance to water and chlorine exposure. The material delivers vibrant colors and long-term durability.

- Chlorine and water resistant
- Custom Printing
- Available in various lengths and dimensions



PENNANT FLAG STRINGS

A string of pennants is an effective and colorful promotional solution, ideal for decorating and enhancing a wide range of events and occasions, such as festivals, openings, promotional campaigns, and commercial initiatives.

Available in both rectangular and triangular formats, they are made from 100% nautical polyester fabric, designed to ensure high resistance and long-lasting durability even in outdoor environments.

The flags are sewn onto webbing or rope to allow quick and easy installation on the desired structures, ensuring maximum visibility.

Thanks to high-resolution digital printing, the pennant flags can be fully customized with logos and graphics without color limitations.

- Custom Printing
- Available in various lengths and dimensions



Our snowbanners are made of nautical polyester, fully customizable and digitally printed fabric. The kit includes the internal flexible fiberglass tension pole 4 eyelets and fixing pegs. Ideal for snowparks, easy and quick to assemble and remove.

Size

Diameter 75 cm
Diameter 150 cm



The customized windsock is nautical polyester cone, digitally printed and resistant to air flow and harsh weather. Blowing inside the sock, the wind changes its position, conveying information about its direction and intensity. At the same time, thanks to customizable fabric, the windsock provides an advertising message with great effect. The customized windsocks are delivered with anodized aluminium poles, rotating hook, carry case and ground fixer.

Windsock Full Kit



- . Carry case
- . XL Fixer
- . Aluminium poles
- . Flag



Sometimes having a backdrop during photo shoots, meetings or festivals is essential. Our backdrops are digitally printed and therefore fully customizable as for the graphic and the colours. The fabric is 100% fireproof polyester. The use of a counterweight is recommended to ensure greater stability.

- Digital printing
- High definition printing
- Ideal for outdoors and indoors
- One-sided
- No color limit
- Available in two sizes:
 - a) 300 x 200 cm (base, height)
 - b) 225 x 225 cm

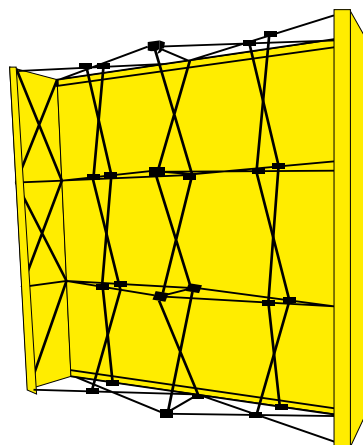
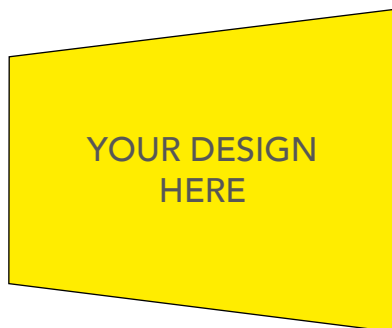

Included transportation bag



The lycra backdrop is a high-impact scenic solution, ideal for events, photo shoots, conferences, and promotional activities. It consists of a lightweight, intuitive-to-assemble tubular aluminum frame, complete with stabilizing feet at the base. The covering is made of stretch lycra fabric, double-sided printed and fully customizable (with different graphics on each side). The elasticity of the lycra ensures a surface that is always taut and free of creases, with a clean and professional visual effect.

- 300x223 cm (base, height)
- Double-sided
- High definition printing
- Ideal for outdoors and indoors



Included transportation bag



SIDE A



SIDE B



elleerre®
Dove c'è passione

RUNNING KIT

- ◆ RACE BIB
- ◆ T-SHIRT
AUTHOR
- ◆ HEABAND
- ◆ ARM SLEEVE
- ◆ CAPS
- ◆ SHOES BAG
- ◆ SPORT BAG



elleerre®
Dove c'è passione

Disposable vest made of cellulose and textile fiber, ripstop, printed in four colours and with numeration. Ideal for marathons, trails and cycling races.

- Customizing with every kind of graphic and colour
- With or without numeration
- Sizes: 22,5x16cm



TNT BIB

Singlet bib made in TNT with side laces.
Size: 40x60cm

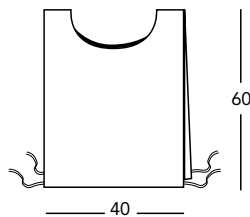

LYCRA BIB

Numbered race bibs made in elastic Lycra.
Size: 47x50cm

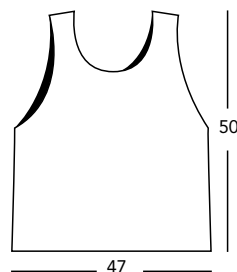

POLYESTER BIB

Numbered race bibs made in stretch polyester.
Size: 75x60cm

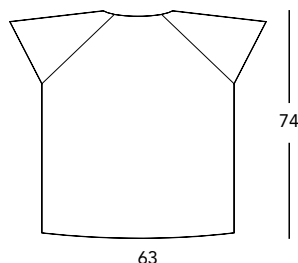

Light and breathable technical shirt. Made of super-soft 100% hypoallergenic polyester fabric. Ideal for all sports, even for Ultra Trail races, and at the same time a designer t-shirt.

MADE IN ELLEERRE for the entire production process from drawing to printing, from packaging to labeling.

The shirts can be enriched and accompanied by a personalized card that tells the story of the shirt, the artist or the project to which it is linked.

- Customizable with any type of graphics or color
- Also with Fluo colors
- Light and breathable
- Hypoallergenic fabric





Thanks to ElleErre bike cover you can protect your bike when carrying and bring it home or in office without dirtying. ElleErre bike cover is made by elasticized polyester fabric, totally customized thanks to the digital printing, without limits color.

It has a practical pocket inside which makes it easily foldable, comfortable to carry without taking up space.

- One size: 163x65 cm
- Machine-washable
- Protect wheels and transmission
- Elastic Polyester

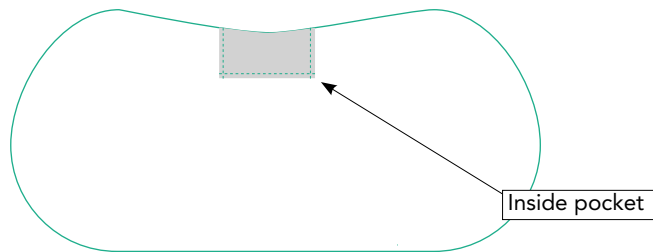

Headband are an important element for those who do sports, hold hair, sweat and dignity. For this reason the Headband are stealing and are a gadget field in all races. Organizers can personalize it with the logo of the event, sponsors, with the graphics they prefer. The headband we produce is elasticized in polyester fabric, comfortable and suitable for staying stable even during movement and physical activity.

From this year ElleErre has the possibility to make it even in fluo colors.

- Customized
- Customized with Fluo colors
- Size: 10x48cm
- Elastic material



The ElleErre thermal head band was developed for performing running, cycling or other activities after the temperature has gotten colder. It is highly insulating thanks its ultra-soft microfiber layer making this an essential accessory for your fall and winter outdoor activities.

The thermal headband by ElleErre has a plush and inviting interior that is soft to the touch promoting maximum comfort against your skin.

The fabric is highly elastic, breathable, has an elevated resistance to pilling and is machine washable.

- Customized
- Customized with Fluo colors
- Size: 10x23cm
- Elastic and insulating material



They have become a must to have in all kits for sporting athletes. A distinctive element, a way to differentiate, a technical element or fashion. From basketball players to ultratrailers, from cyclists to volleyballs: all are crazy about arm sleeve. ElleErre arm sleeves are customizable with any graphics and any color: even fluorescent.



THERMAL

Hot component that protects from the cold.



EASY TO USE

If it gets too hot, turn it up easily on your wrist



ElleErre Speed Socks: the super aerodynamic sock for maximum performance and an enviable look.

Speed Socks are produced to adhere perfectly to the ankle and calf and thanks to the absence of elastic, they promote blood circulation and minimizes friction with the air.

The upper part of the socks is made from an elastic polyester fabric. It has a grooved technical structure with vertical stripes and an internal side seam to facilitate aerodynamics. The upper portion adheres perfectly to the calf thanks to a silicone band which guarantees perfect stability of the sock even during longer rides.

The extremely technical lower part is composed of Carbon Resistex, a continuous filament of conductive material based on active carbon and textile fibers. This material improves the dispersion of moisture by favoring the evaporation of sweat. With less moisture in contact with the skin there is a greater sensation of well-being and comfort.

Further, carbon has been shown to improve the electrical performance of the human body by promoting regular blood circulation.

Suitable for temperatures ranging from 10° to 40°C.

COMPOSITION	
Top portion:	
•	Polyester, Elastane
Bottom portion:	
•	55% X-Dry (PP)
•	35% X-Pro (PA)
•	6% Carbon Resistex
•	4% Lycra

- Ideal for time trial, track or road cycling
- Brilliant colors thanks to the highest quality digital printing
- Perfect fit
- Elegant look
- Adherence to the leg without creases
- Minimal stitching on the inside of the leg
- STANDARD 100 certified fabric by OEKO-TEX®
- Minimum order: 30 pcs

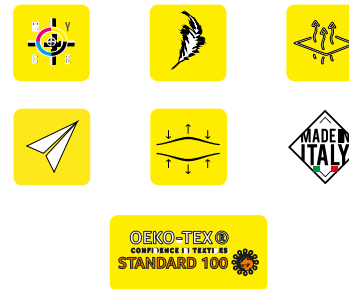

Light Cap is the perfect cap for all outdoor sports: cycling, running, trail running, etc...
"Light Cap" is made with a perforated elastic fabric which facilitates heat dissipation, ensuring the best possible breathability and lightness.

Main features: breathable, elastic, light and machine-washable.
Rigid opposable visor which also makes it ideal for use under the helmet.

- Weight: 25 g
- Fabric: polyester 76% - elastane 24%
STANDARD 100 by OEKO-TEX®
- Black "wipe-sweat" interior band in polyester
- Rigid and opposable polyester visor
- Machine-washable up to 40°
- One-size-fits-all
- Minimum order: 30 pcs

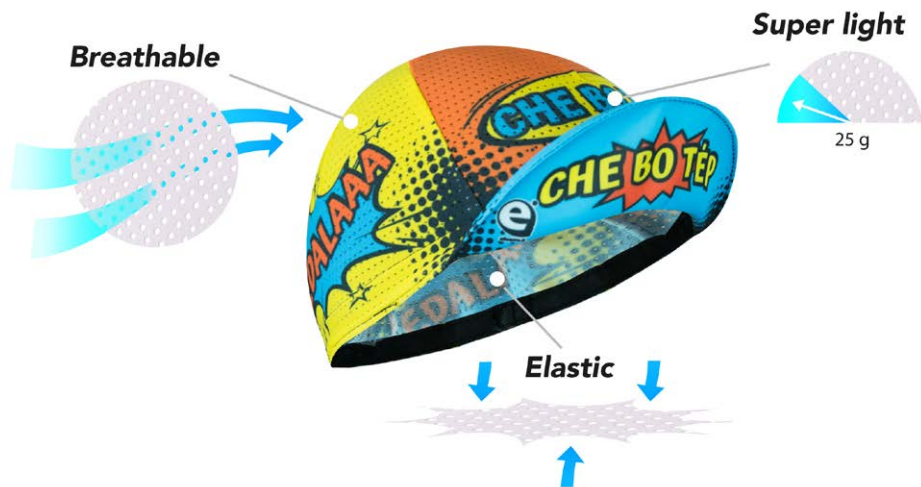
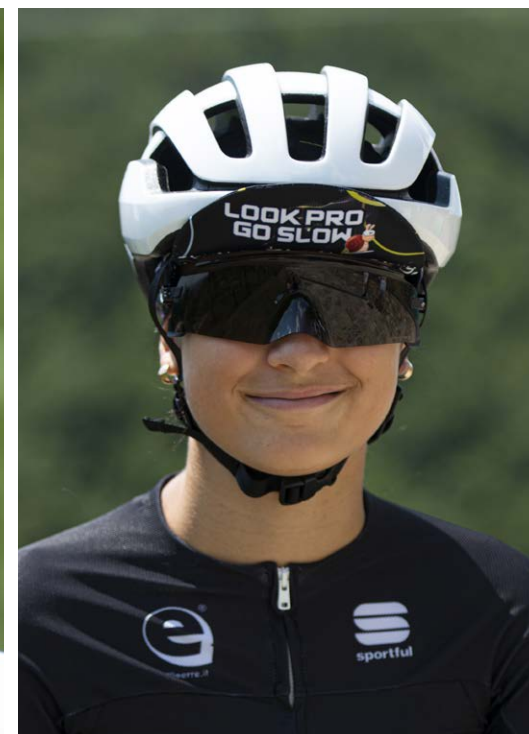

The ElleErre neck warmer is suitable for any sports activity, in order to protect yourself from cold and wind.

The ElleErre neck warmer is made of technical fabric 100% polyester elastic, tubular and fully customizable.

Softness, warmth, and breathability are the main features of the ElleErre neck warmer.

- Fabric: 100% polyester elastic
- Customizable with any type of graphics or color
- Possibility of having fluorescent colors
- Dimensions: 40x25 cm
- Thermal, breathable, and elastic material
- Easily washable in the washing machine



Any sport requires a change of shoes, even just a replacement between before and after the activity. We can customize the shoes bag that every athlete brings with them. The ElleErre shoes bags are customizable on both sides, they have a double zipper for the opening, an handy handle and a reinforced eyelet for air exchange. They are ideal as gadgets, such as prizes or race packs, as a kit of a team uniform of every sport. High print quality and brilliant colors make the ElleErre shoes bags an excellent communication and sponsorship tool.

- Customizable with any type of graphics or colors
- Double zipper to facilitate opening
- Practical handle
- Reinforced eyelet for air change
- Dimensions: 34x18 cm, width 16 cm

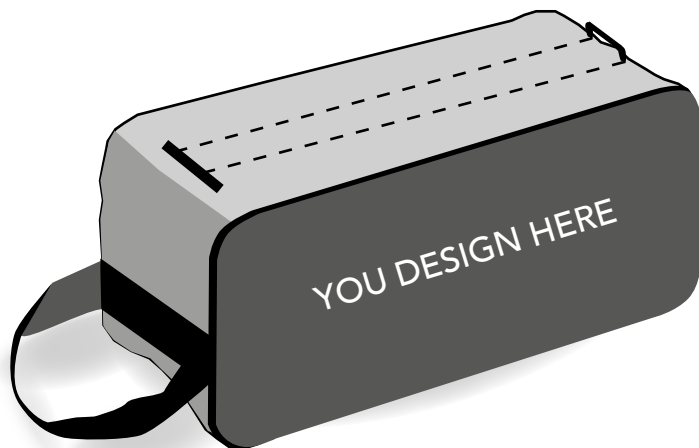

The ElleErre garment bag is perfect for carrying around all your personal belongings when out of home. Both sides are customizable in a wide range of colours, even fluo ones. The bag is made of fireproof polyester fabric, has a zipper on the top and two handles. The standard measures are 60 x 38 cm but customized sizes are also available.

- Graphic and colours fully customizable
- Breathable polyester fabric
- With zipper and practical handles
- Easy to use
- Available in two sizes: 38x50 cm or 38x60 cm

